

# Cablage PT100 3pb

Remarque  
 1 torsadé avec 3  
 2 torsadé avec 4

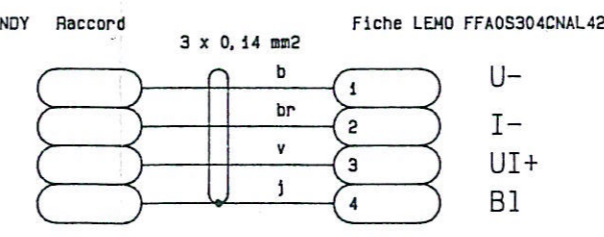
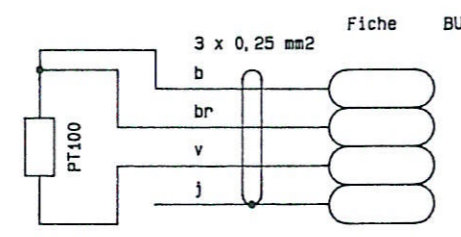
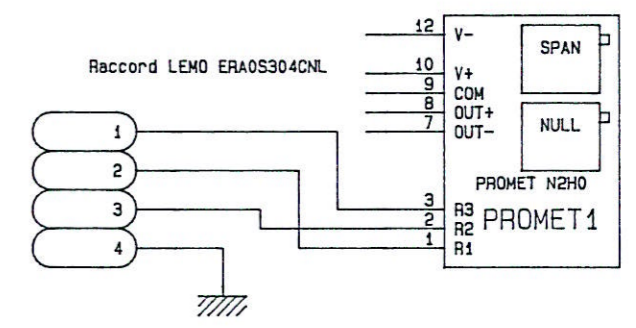
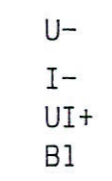
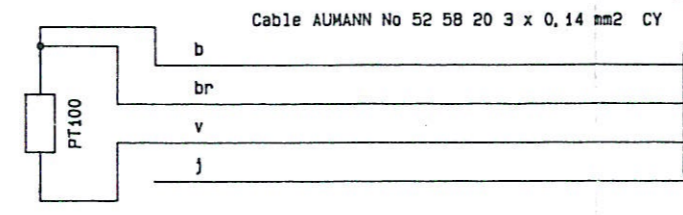
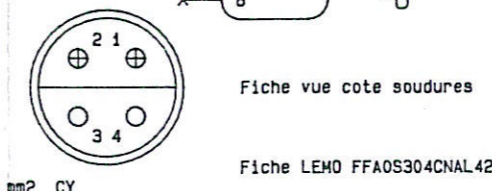
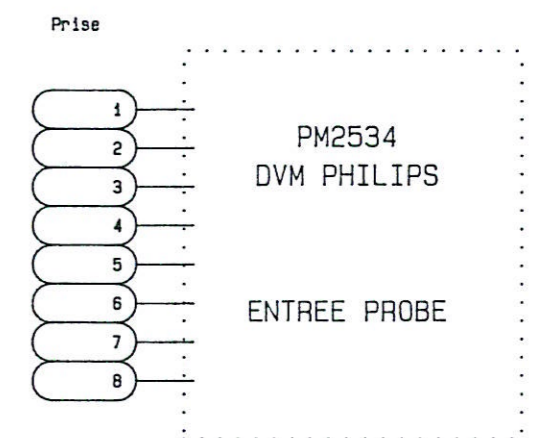
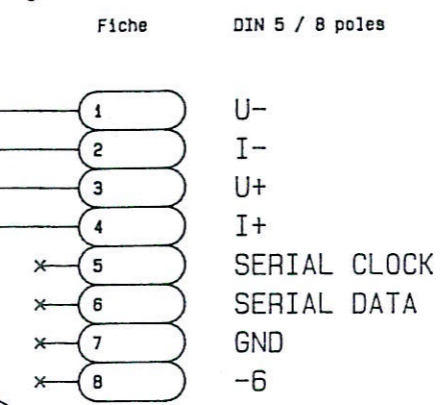
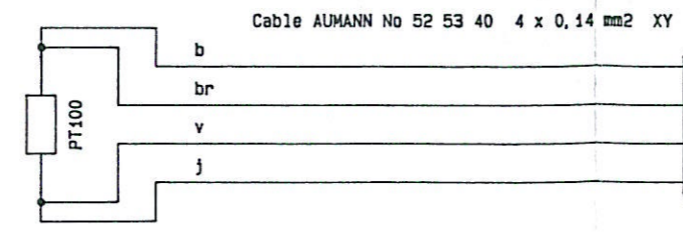
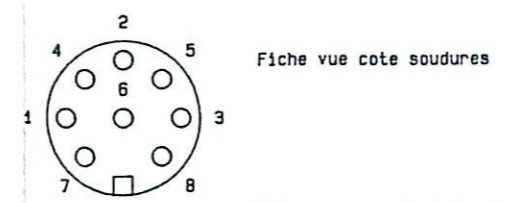
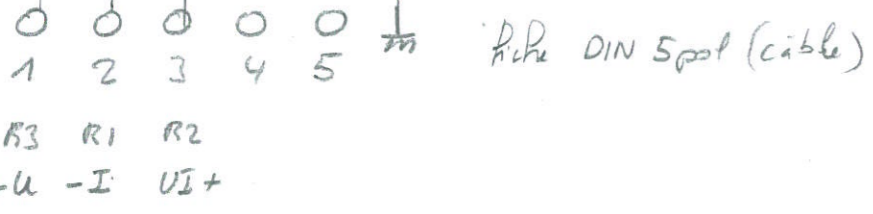
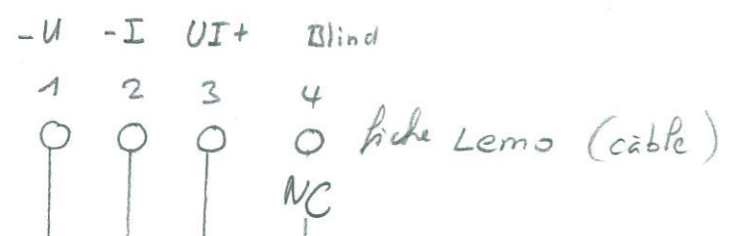

4 x 0,14 mm2 XY AUMANN 52 53 40 diam. 3,7 +-0,2 mm 0,138 ohm/m  
 3 x 0,25 mm2 CY AUMANN 52 67 60 diam. 4,5 +-0,2 mm 0,077 ohm/m  
 3 x 0,14 mm2 CY AUMANN 52 58 20 diam. 3,9 +-0,2 mm 0,138 ohm/m

Observations :	CABLPTC.SCH	Appareil No:	A3
Modifications:		Sheet No:	
MONTAGE SONDE		Ech.	Dessine R. Crausaz
PT100		Date	11.05.1988
THERMOMETRE		Etude	R. Crausaz
		Revise	27.09.1991
OBSERVATOIRE DE GENEVE Tel. (022) 755.26.11		LE-IN-1E-B1101	